

YDS-3AMF-SC501AI V1.0
5MP SmartSens SC501AI MIPI Interface M12
Fixed Focus Camera Module



Front View



Back View

Specifications

Camera Module No.	YDS-3AMF-SC501AI V1.0
Resolution	5MP
Image Sensor	SC501AI
Sensor Type	1/2.7"
Pixel Size	2.0 um x 2.0 um
EFL	3.00 mm
F.NO	2.00
Pixel	2880 x 1620
View Angle	142.0°(DFOV) 100.0°(HFOV) 73.0°(VFOV)
Lens Dimensions	13.60 x 13.60 x 18.00 mm
Module Size	40.05 x 13.70 mm
Module Type	Fixed Focus
Interface	MIPI
Auto Focus VCM Driver IC	None
Lens Model	YDS-LENS-MJ7010A
Lens Type	650nm IR Cut
Operating Temperature	-30°C to +85°C
Mating Connector	DF30FC-30DS-0.4V



YDS-3AMF-SC501AI V1.0 5MP SmartSens SC501AI MIPI Interface M12 Fixed Focus Camera Module



Top View



Side View



Bottom View

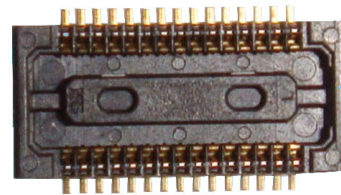

Mating Connector

ROHS

1	AGND
2	NC
3	NC
4	NC
5	SIOD
6	FSYNC
7	SIOC
8	AVDD2.8V
9	XSHUTDN
10	MDP2
11	NC
12	MDN2
13	DGND
14	DGND
15	FSYNC
16	MDP1
17	PWDNB
18	MDN1
19	NC
20	DGND
21	NC
22	MCP
23	NC
24	MCN
25	NC
26	DGND
27	NC
28	MDP0
29	NC
30	MDN0
31	NC
32	DGND
33	NC
34	MCLK
35	MDP3
36	DVDD1.2V
37	MDN3
38	DOVDD1.8V
39	DGND
40	DGND

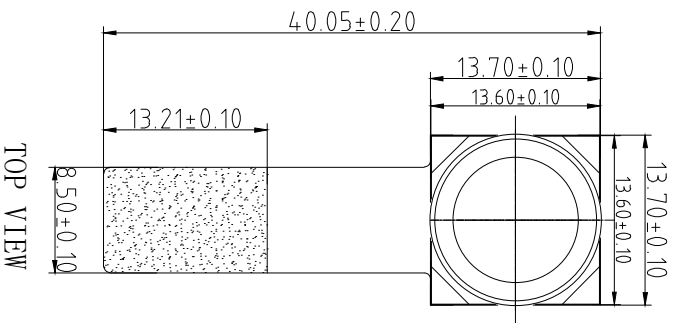

TOP VIEW

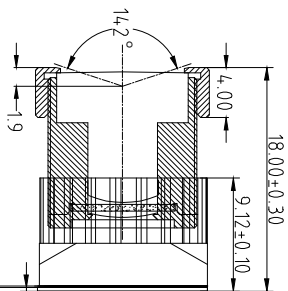

SIDE VIEW

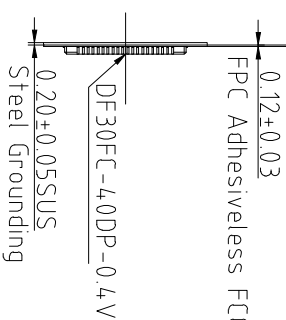

BOTTOM VIEW

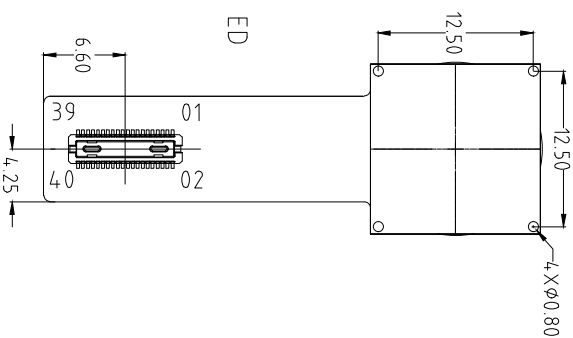

NOTE:
1. The device slave address: 7'h30

Parameters:

1、Sensor specification:

Image Sensor: SC501AI
Pixel: 2.0um×2.0um
Lens Type: 1/2.7
Important Voltage Description: DVDD1.2V (external power supply);

2、Lens specification:

FOV: 14.2°(D);100°(H);73°(V)
F/N.O.: 2.0
TV distortion: <35%
Focal length: 3.0mm
Composition: 5E+IR FILTER
IR Cut Coating: 650nm±10nm@50%

Designed By

Kevin

Model Name:

3AMF-SC501AI V1.0

Checked By

Aouly Yan

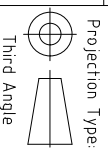

Unit: mm

Scale: 1:1

Sheet: 1 of 1

Version: 1/0

A

B

C

D

E

3

3

2

2

1

1



SMARTSENS

CMOS图像传感器

CMOS IMAGE SENSOR

SC501AI 产品单页

SC501AI Product Flyer

- 高性能16:9宽画幅3K视频输出
High performance 16:9 aspect ratio 3K video output
- 暗光、色彩全性能提升
More improved performance,
specifically low-light imaging and color expression



公司简介 | Company Profile

思特威(上海)电子科技股份有限公司(SmartSens Technology)是一家从事CMOS图像传感器芯片产品研发、设计及服务的高新技术企业,2011年创立,总部设立于中国上海,在北京、深圳、杭州、香港、新竹以及美国圣何塞等多个城市设有研发中心与销售办公室,网络遍及全球。

思特威以创新为驱动,专注于为客户提供面向未来和全球领先的CMOS图像传感器芯片产品。凭借一支精于创新、覆盖全球的研发团队,思特威自主研发出了优秀的夜视全彩技术、独创领先的DSI技术、Stack BSI的全局曝光技术等诸多卓越技术。

自成立以来,思特威一直以客户需求为核心,致力于为客户提供高质量的视频解决方案。公司产品也不断成熟并逐步确立了安防领域行业领先地位,产品遍及安防监控、车载影像、机器视觉及消费类电子产品(运动相机、无人机、扫地机器人、智能家用摄像头)等应用领域。2017年起,思特威已连续多年在CIS产品安防领域全球市场占有率上保持第一,并在机器视觉、人工智能应用等新兴领域不断拓展创新。

SmartSens Technology(Shanghai) Co., Ltd. is a high-performance CMOS image sensing (CIS) chip design company. The company, founded in 2011, is headquartered in Shanghai and has both research centers and sales offices in various cities around the world, including Beijing, Shenzhen, Hangzhou, Hong Kong, Hsinchu and San Jose, California. SmartSens is dedicated to providing future-oriented and world-leading CMOS image sensing products. With an international and accomplished research team, SmartSens owns a suite of proprietary technologies, including full color night vision, DSI Pixel, global exposure built on voltage domain architecture and Stack BSI processes, among many others.

SmartSens has always kept the needs of the customer first, constantly innovating with the goal of providing the customer with high-quality video capturing solutions, with products in Security & Surveillance, Automotive, Machine Vision, Consumer Electronics (sports cameras, drones, automatic vacuums, smart home), and other application fields. Since 2017, SmartSens has maintained its lead in the CIS Security & Surveillance global market share for two consecutive years, and it has had achievements in machine vision, artificial intelligence, among other applications.

规格说明 | Specifications

项目 Item	参数 Parameters
Resolution	5MP
Pixel Array	2888H x 1628V
Pixel Size	2.0µm x 2.0µm
Optical Format	1/2.7"
Max Frame Rate	2880H x 1620V@30fps
Output Interface	8/10-bit 1/2/4 Lane MIPI
Output Format	RAW RGB
CRA	15°
Sensitivity	3628mV/LUX*S
Dynamic Range	79dB linear mode
SNR	39dB
Operation Temperature	-30°C to +85°C
Best IQ Temperature	-20°C to +60°C
Power Supply	Analog = 2.8 V
	Digital = 1.2V
Package	I/O = 1.8V
	41-pin CSP
Package Size	6.45mm x 4.26mm



WeChat



LinkedIn

Website www.smartsensotech.com
E-mail CS@smartsensotech.com

产品特性 | Features

■ 宽画幅16:9比例, 可实现1620P, 3K 视频输出

Display Friendly 16:9 for 1620P, 3K Video Output

■ 850/940nm 近红外增益

850/940 nm Near IR Improvement

■ 低功耗

Low Power Consumption

应用场景 | Applications

■ AI安防摄像头

AI Security Cameras

■ 工业安防摄像头

Industrial Security Cameras

■ 视频会议摄像头

Video Conference Cameras

■ 上海办公室

上海市徐汇区宜山路1009号创新大楼11F
11F, No.1009, Yishan Road, Xuhui District, Shanghai
Tel: 021-6485-3570

■ 深圳办公室

深圳市龙岗区坂田街道雅宝路1号星河 WORLD B座大厦B-2908B
B2908B, Building B, Galaxy WORLD, No.1 Yabao Road,
Bantian Street, Longgang District, ShenZhen
Tel: 0755-2373-9713

■ 北京办公室

北京市经济技术开发区荣华南路2号大族广场T6座2201室
Room 2201, Building T6, Dazhu Plaza, No.2, South Ronghua
Road, Economic-Technological Development Area, Beijing
Tel: 010-6786-3626

■ 香港办公室

香港观塘鸿图道21号讯科中心10楼F室
RM F, 10/F, INFOTECH CENTRE, 21 HUNG TO RD

■ 美国 (圣何塞)

加利福尼亚州圣何塞市史蒂文森森克里克大道4340号280室
4340 Stevens Creek Blvd, Suite 280, San Jose CA95129
Tel: +1 408 981 6626

YDS-LENS-MJ7010A

SPECIFICATION

1. FOR 1/3" SENSOR
2. IMAGE HEIGHT $\phi 6.4$
3. EFL=3mm
4. WORKING F/NO.=2.0
5. BFL=4.7mm
6. FOV=142°
7. DISTORTION=35%
8. RELATIVE ILLUMINATION=70%($\gamma=1$)
9. CONSTRUCTION: 5E
10. THREAD :M12X0.5P
11. IR FILTER 650±10nm

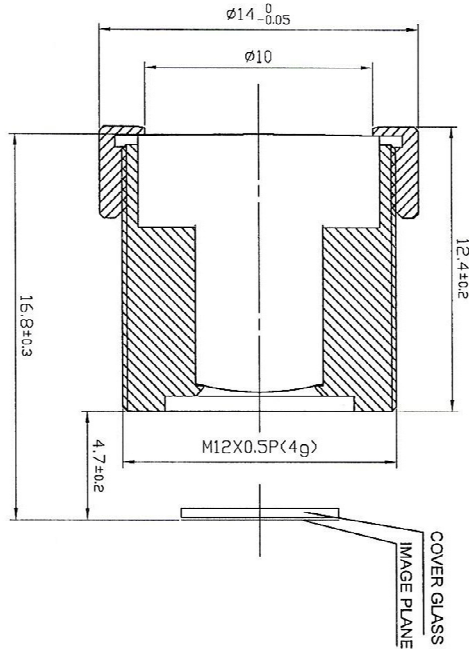

⑤									
④									
③									
②									
①									
修改记录 REVISION RECORD		姓名 NAME	日期 DATE	公差 TOLERANCE		材料 MATERIAL	图形编号 DRAWING NO.	版本 REV.	日期 DATE
				±0.1 ±0.05 ±0.03 ±1 ±0.5		名称 NAME	SPR001	A-01	日期 DATE
				3RD ANGLE PROJIN		名称 NAME			日期 DATE
				单位 UNIT		名称 NAME			日期 DATE
				比例 SCALE		名称 NAME			日期 DATE
				12:1		名称 NAME			日期 DATE

0.4 mm Pitch, 0.9 mm Height, Board-to-Board / Board-to-FPC Connectors

DF30 Series

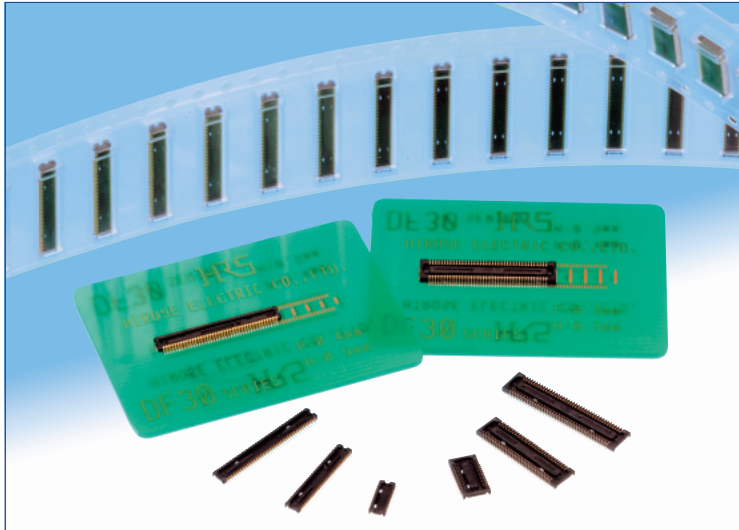

Extremely small size

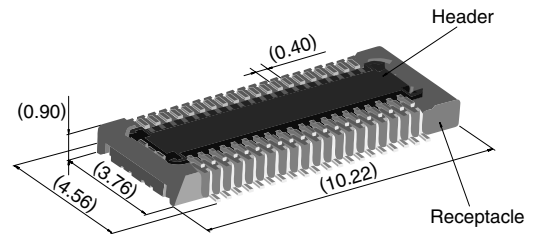

40 positions shown

Overview

Continuous miniaturization and increased component density on PCB created demand for extremely low profile connectors. This series is addition of a new extremely low profile connectors to Hirose's wide range of high reliability board-to-board/board-to-FPC connection solutions.

Features

1. Contact reliability

Concentration of the contact's normal forces at the single point assures good contact wipe and electrical reliability, while confirming the fully mated condition with a definite tactile click.

2. Self alignment

Recognizing the difficulties of mating extremely small connectors in limited spaces the connectors will self align in horizontal axis within 0.3 mm.

3. Automatic board placement

Packaged on tape-and-reel the plug and headers have sufficiently large flat areas to allow pick-up with vacuum nozzles of automatic placement equipment.

4. Variety of contact positions and styles

Available in standard contact positions of: 20, 22, 24, 30, 34, 40, 50, 60, 70 and 80 with and without metal fittings. Addition of metal fittings does not affect external dimensions of the connectors.

Smaller contact positions are also available.

5. Support for continuity test connector

Connectors which have increased insertion and removal durability are available for continuity tests. Contact your Hirose sales representative for details.

Applications

Cellular phones, PDA's, mobile computers, digital cameras, digital video cameras, and other devices demanding high reliability connections in extremely limited spaces.

Low profile

Increased mated retention

High contact reliability

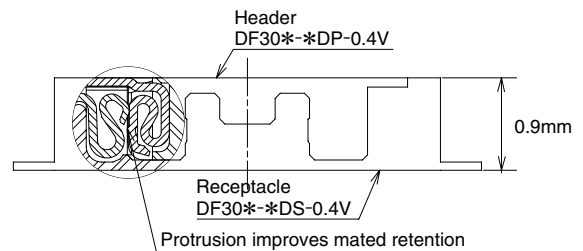

Self alignment



Product Specifications

Rating	Rated current 0.3A Rated voltage 30V AC	Operating temperature range : -35°C to 85°C (Note 1) Operating humidity range : Relative humidity 20% to 80%	Storage temperature range -10°C to 60°C (Note 2) Storage humidity range Relative humidity 40% to 70% (Note 2)
--------	--	---	--

Item	Specification	Conditions
1. Insulation resistance	50 MΩ min.	100V DC
2. Withstanding voltage	No flashover or insulation breakdown.	100V AC / one minute
3. Contact resistance	100 mΩ max.	100 mA
4. Vibration	No electrical discontinuity of 1 μs or more	Frequency: 10 to 55 Hz, single amplitude of 0.75mm, 2 hours, 3 axis
5. Humidity	Contact resistance: 100 mΩ max. Insulation resistance: 25 MΩ min.	96 hours at temperature of 40°C±2°C and RH of 90% to 95%
6. Temperature cycle	Contact resistance: 100 mΩ max. Insulation resistance: 50 MΩ min.	Temperature: -55°C→+5°C to +35°C→+85°C→+5°C to +35°C Duration: 30→10→30→10(Minutes) 5 cycles
7. Durability (insertions/withdrawals)	Contact resistance: 100 mΩ max.	50 cycles(Connector for conductivity tests: 500 cycles)
8. Resistance to soldering heat	No deformation of components affecting performance.	Reflow: At the recommended temperature profile Manual soldering: 300°C for 3 seconds

Note 1: Includes temperature rise caused by current flow.

Note 2: The term "storage" refers to products stored for long period of time prior to mounting and use. Operating temperature range and humidity range covers non-conducting condition of installed connectors in storage, shipment or during transportation.

Materials and Finishes

Connectors	Component	Material	Finish	Remarks
Receptacles and Headers	Insulator	LCP	Color : Black	UL94V-0
	Contacts	Phosphor bronze	Gold plated	————
	Metal fittings	Phosphor bronze	Tin-copper plated	————

Ordering information

Receptacles and Headers

DF30 **FC** - ***** **DS - 0.4** **V** **(**)**
1 2 3 4 5 6 7

1 Series name: DF30	5 Contact pitch: 0.4 mm
2 Configuration FB: With metal fittings, without bosses FC: Without metal fittings, without bosses CJ: Connector for conductivity tests	6 Termination section V: Straight SMT
3 Number of positions: 20, 22, 24, 30, 34, 40, 50, 60, 70, 80	7 Packaging (81): Embossed tape packaging (5,000 pieces per reel) (82): Embossed tape packaging (1,000 pieces per reel)
4 Connector type DS: Double row receptacle DP: Double row header	

■ Receptacles (without metal fittings)



◆ Recommended PCB mounting pattern



Recommended solder paste thickness: 120 μm

[Specification number] -**, (**)
(81): Embossed tape packaging (5,000 pieces per reel)

* Tolerances non- accumulative.

Unit: mm

Part Number	CL No.	Number of contacts	A	B	C
DF30FC-20DS-0.4V(**)	CL684-1109-8-**	20	6.22	3.6	1.2
DF30FC-22DS-0.4V(**)	CL684-1110-7-**	22	6.62	4.0	1.2
DF30FC-24DS-0.4V(**)	CL684-1111-0-**	24	7.02	4.4	1.2
DF30FC-30DS-0.4V(**)	CL684-1112-2-**	30	8.22	5.6	1.2
DF30FC-34DS-0.4V(**)	CL684-1113-5-**	34	9.02	6.4	1.36
DF30FC-40DS-0.4V(**)	CL684-1078-6-**	40	10.22	7.6	1.6
DF30FC-50DS-0.4V(**)	CL684-1114-8-**	50	12.22	9.6	2.0
DF30FC-60DS-0.4V(**)	CL684-1082-3-**	60	14.22	11.6	2.4
DF30FC-70DS-0.4V(**)	CL684-1115-0-**	70	16.22	13.6	2.8
DF30FC-80DS-0.4V(**)	CL684-1116-3-**	80	18.22	15.6	3.2

Note 1: Order by number of reels.

Note 2: Receptacles with 24 or fewer contacts positions will not have recessed areas.



YDS CAMERA MODULE

your best camera partner

Camera Module Pinout Definition Reference Chart

OmniVision	Sony	Samsung	On-Semi	Aptina	Himax	GalaxyCore	PixArt	SmartSens	Sensors
Pin Signal		Description							
DGND	GND	ground for digital circuit							
AGND		ground for analog circuit							
PCLK	DCK	DVP PCLK output							
XCLR	PWDN	XSHUTDOWN	STANDBY	power down active high with internal pull-down resistor					
MCLK	XVCLK	XCLK	INCK	system input clock					
RESET	RST	reset active low with internal pull-up resistor							
NC	NULL	no connect							
SDA	SIO_D	SIOD	SCCB data						
SCL	SIO_C	SIOC	SCCB input clock						
VSYNC	XVS	FSYNC	DVP VSYNC output						
HREF	XHS	DVP HREF output							
DOVDD	power for I/O circuit								
AFVDD	power for VCM circuit								
AVDD	power for analog circuit								
DVDD	power for digital circuit								
STROBE	FSTROBE	strobe output							
FSIN	synchronize the VSYNC signal from the other sensor								
SID	SCCB last bit ID input								
ILPWM	mechanical shutter output indicator								
FREX	frame exposure / mechanical shutter								
GPIO	general purpose inputs								
SLASEL	I2C slave address select								
AFEN	CEN chip enable active high on VCM driver IC								
MIPI Interface									
MDN0	DN0	MD0N	DATA_N	DMO1N	MIPI 1st data lane negative output				
MDP0	DP0	MD0P	DATA_P	DMO1P	MIPI 1st data lane positive output				
MDN1	DN1	MD1N	DATA2_N	DMO2N	MIPI 2nd data lane negative output				
MDP1	DP1	MD1P	DATA2_P	DMO2P	MIPI 2nd data lane positive output				
MDN2	DN2	MD2N	DATA3_N	DMO3N	MIPI 3rd data lane negative output				
MDP2	DP2	MD2P	DATA3_P	DMO3P	MIPI 3rd data lane positive output				
MDN3	DN3	MD3N	DATA4_N	DMO4N	MIPI 4th data lane negative output				
MDP3	DP3	MD3P	DATA4_P	DMO4P	MIPI 4th data lane positive output				
MCN	CLKN	CLK_N	DCKN	MIPI clock negative output					
MCP	CLKP	MCP	CLK_P	DCKN	MIPI clock positive output				
DVP Parallel Interface									
D0	DO0	Y0	DVP data output port 0						
D1	DO1	Y1	DVP data output port 1						
D2	DO2	Y2	DVP data output port 2						
D3	DO3	Y3	DVP data output port 3						
D4	DO4	Y4	DVP data output port 4						
D5	DO5	Y5	DVP data output port 5						
D6	DO6	Y6	DVP data output port 6						
D7	DO7	Y7	DVP data output port 7						
D8	DO8	Y8	DVP data output port 8						
D9	DO9	Y9	DVP data output port 9						
D10	DO10	Y10	DVP data output port 10						
D11	DO11	Y11	DVP data output port 11						

www.YDSCAM.com sales@ydscam.com Phone (WeChat, QQ): (+86) 177 2732 6718

All rights reserved @ YingDeShun Co. Ltd. Specifications subject to change without notice.

Cameras Applications



IMAGING DEVICES



Camera Reliability Test

Reliability Inspection Item		Testing Method	Acceptance Criteria	
Category	Item			
Environmental	Storage Temperature	High 60°C 96 Hours	Temperature Chamber	No Abnormal Situation
		Low -20°C 96 Hours	Temperature Chamber	No Abnormal Situation
	Operation Temperature	High 60°C 24 Hours	Temperature Chamber	No Abnormal Situation
		Low -20°C 24 Hours	Temperature Chamber	No Abnormal Situation
	Humidity	60°C 80% 24 Hours	Temperature Chamber	No Abnormal Situation
	Thermal Shock	High 60°C 0.5 Hours Low -20°C 0.5 Hours Cycling in 24 Hours	Temperature Chamber	No Abnormal Situation
Physical	Drop Test (Free Falling)	Without Package 60cm	10 Times on Wood Floor	Electrically Functional
		With Package 60cm	10 Times on Wood Floor	Electrically Functional
	Vibration Test	50Hz X-Axis 2mm 30min	Vibration Table	Electrically Functional
		50Hz Y-Axis 2mm 30min	Vibration Table	Electrically Functional
		50Hz Z-Axis 2mm 30min	Vibration Table	Electrically Functional
	Cable Tensile Strength Test	Loading Weight 4 kg 60 Seconds Cycling in 24 Hours	Tensile Testing Machine	Electrically Functional
Electrical	ESD Test	Contact Discharge 2 KV	ESD Testing Machine	Electrically Functional
		Air Discharge 4 KV	ESD Testing Machine	Electrically Functional
	Aging Test	On/Off 30 Seconds Cycling in 24 Hours	Power Switch	Electrically Functional
	USB Connector	On/Off 250 Times	Plug and Unplug	Electrically Functional



Camera Inspection Standard

Inspection Item		Inspection Method	Standard of Inspection		
Category	Item				
Appearance	FPC/ PCB	Color	The Naked Eye	Major Difference is Not Allowed.	
		Be Torn/Chopped	The Naked Eye	Copper Crack Exposure is Not Allowed.	
		Marking	The Naked Eye	Clear, Recognizable (Within 30cm Distance)	
	Holder	Scratches	The Naked Eye	The Inside Crack Exposure is Not Allowed	
		Gap	The Naked Eye	Meet the Height Standard	
		Screw	The Naked Eye	Make Sure Screws Are Presented (If Any)	
		Damage	The Naked Eye	The Inside Crack Exposure is Not Allowed	
	Lens	Scratch	The Naked Eye	No Effect On Resolution Standard	
		Contamination	The Naked Eye	No Effect On Resolution Standard	
		Oil Film	The Naked Eye	No Effect On Resolution Standard	
		Cover Tape	The Naked Eye	No Issue On Appearance.	
	Function	Image	No Communication	Test Board	Not Allowed
			Bright Pixel	Black Board	Not Allowed In the Image Center
Dark Pixel			White board	Not Allowed In the Image Center	
Blurry			The Naked Eye	Not Allowed	
No Image			The Naked Eye	Not Allowed	
Vertical Line			The Naked Eye	Not Allowed	
Horizontal Line			The Naked Eye	Not Allowed	
Light Leakage			The Naked Eye	Not Allowed	
Blinking Image			The Naked Eye	Not Allowed	
Bruise			Inspection Jig	Not Allowed	
Resolution			Chart	Follows Outgoing Inspection Chart Standard	
Color			The Naked Eye	No Issue	
Noise			The Naked Eye	Not Allowed	
Corner Dark			The Naked Eye	Less Than 100px By 100px	
Color Resolution			The Naked Eye	No Issue	
Dimension	Height	The Naked Eye	Follows Approval Data Sheet		
	Width	The Naked Eye	Follows Approval Data Sheet		
	Length	The Naked Eye	Follows Approval Data Sheet		
	Overall	The Naked Eye	Follows Approval Data Sheet		

YDSCAM Package Solutions

YDS Camera Module



Complete with Lens Protection Film



Tray with Grid and Space



Place Cameras on the Tray



YDSCAM Package Solutions

Full Tray of Cameras



Cover Tray with Lid

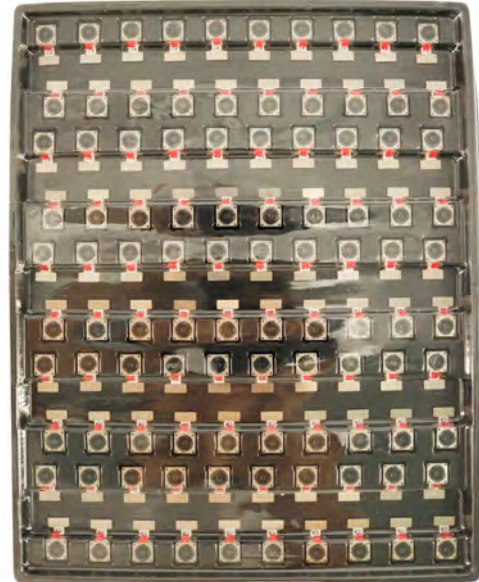

Place Tray into Anti-Static Bag



Vacuum the Anti-Static Bag



YDSCAM Package Solutions

Sealed Vacuum Anti-Static Bag with Labels

1. Model and Description 2. Quantity 3. Manufacturing Date Code 4. Caution



YDSCAM Package Solutions

Place Foam Sheets Between Tray Bags



Foam Sheets are Larger Than Trays



Place Foam Sheets and Trays into Box



Foam Sheets are Tightly Fitting in Box



Seal the Carbon Box



Label the Carbon Shipping Box





YDSCAM Package Solutions

USB Camera Module

Complete with Lens Protection Film



Place Camera Sample into Anti-Static Bag

Place USB Cameras into Tray



Seal the Tray with Anti-Static Bag

Label the Carbon Shipping Box



YDSCAM Package Solutions

Place Camera Sample into Anti-Static Bag



Place Connectors into Anti-Static Bag



Label the Sample Bags



Place Connectors into Reel



Place Samples into the Carbon Box



Place Connectors into the Carbon Box





YDS CAMERA MODULE

your best camera partner

Company YDSCAM

YingDeShun Co. Ltd. (YDS) was established in 2017, a next-generation technology driven manufacturer specialized in research, design, and produce of audio and video products. YDS is occupying 20,000 square feet automated plants with 100 employees of annual throughput 30,000,000 units cameras.

YDS provides OEM, ODM design, contract manufacturing, and builds the camera products. You may provide the requirements to us, even with a hand draft, our sales and engineering work together to meet your needs. We consider ourselves your last-term partner in developing practical and innovative solutions.

Our team covers everything from initial concept development to mass produced product. YDS specializes in customized camera design, raw material, electronic engineering, firmware/software development, product testing, and packing design. Our experienced strategic supply systems offer a robust and dependable manufacturing capacity for orders of various sizes.

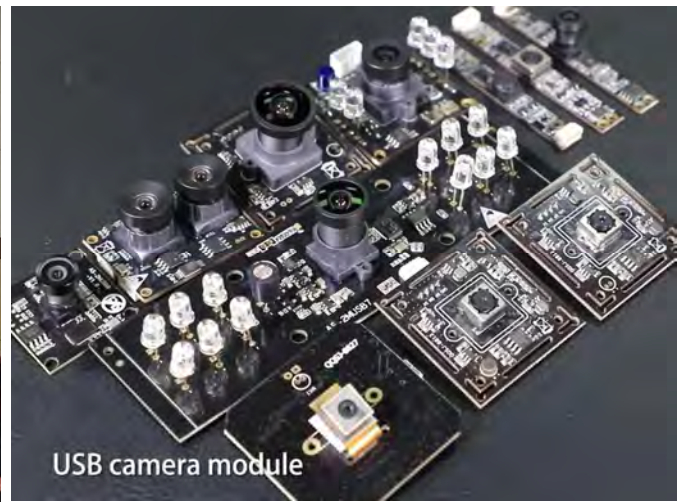

Limited Warranty

YDS provides the following limited warranty if you purchased the Product(s) directly from YDS company or from YDS's website www.YDSCAM.com. Product(s) purchased from other sellers or sources are not covered by this Limited Warranty. YDS guarantees that the Product(s) will be free from defects in materials and workmanship under normal use for a period of one (1) year from the date you receive the product ("Warranty Period").

For all Product(s) that contain or develop material defects in materials or workmanship during the Warranty Period, YDS will, at its sole option, either: (i) repair the Product(s); (ii) replace the Product(s) with a new or refurbished Product(s) (replacement Product(s) being of identical model or functional equivalent); or (iii) provide you a refund of the price you paid for the Product(s).

This Limited Warranty of YDS is solely limited to repair and/or replacement on the terms set forth above. YDS is not reliable or responsible for any subsequent events.



www.YDSCAM.com sales@ydscom.com Phone (WeChat, QQ): (+86) 177 2732 6718

All rights reserved @ YingDeShun Co. Ltd. Specifications subject to change without notice.



YDS CAMERA MODULE

your best camera partner

YDS Strength

Powerful Factory



Professional Service



Promised Delivery



www.YDSCAM.com sales@ydscam.com Phone (WeChat, QQ): (+86) 177 2732 6718

All rights reserved @ YingDeShun Co. Ltd. Specifications subject to change without notice.